

Austin Lynx™ 12 V SMT Non-isolated Power Modules: 10 – 14Vdc input; 1.2Vdc to 5.5Vdc Output; 10A Output Current

RoHS Compliant



Applications

- Distributed power architectures
- Intermediate bus voltage applications
- Telecommunications equipment
- Servers and storage applications
- Networking equipment

Features

- Compliant to RoHS EU Directive 2002/95/EC (-Z versions)
- Compliant to ROHS EU Directive 2002/95/EC with lead solder exemption (non-Z versions)
- Delivers up to 10A of output current
- High efficiency – 93% at 3.3V full load ($V_{IN} = 12.0V$)
- Small size and low profile:
33.00 mm x 13.46 mm x 8.28 mm
(1.300 in x 0.530 in x 0.326 in)
- Low output ripple and noise
- High Reliability:
Calculated MTBF = 4.4 M hours at 25°C Full-load
- Line Regulation: 0.3% (typical)
- Load Regulation: 0.4% (typical)
- Temperature Regulation: 0.4% (typical)
- Remote On/Off
- Remote Sense
- Output overcurrent protection (non-latching)
- Overtemperature protection
- Wide operating temperature range (-40°C to 85°C)
- *UL** 60950-1 Recognized, *CSA*† C22.2 No. 60950-1-03 Certified, and *VDE*‡ 0805:2001-12 (EN60950-1) Licensed
- ISO** 9001 and ISO 14001 certified manufacturing facilities

Description

Austin Lynx™ 12V SMT (surface mount technology) power modules are non-isolated DC-DC converters that can deliver up to 10A of output current with full load efficiency of 93% at 3.3V output. These modules provide a precisely regulated output voltage ranging from 1.2Vdc to 5.5Vdc over a wide range of input voltage ($V_{IN} = 10 - 14Vdc$). Their open-frame construction and small footprint enable designers to develop cost- and space-efficient solutions. Standard features include remote On/Off, remote sense, output voltage adjustment, overcurrent and overtemperature protection.

* *UL* is a registered trademark of Underwriters Laboratories, Inc.

† *CSA* is a registered trademark of Canadian Standards Association.

‡ *VDE* is a trademark of Verband Deutscher Elektrotechniker e.V.

** *ISO* is a registered trademark of the International Organization of Standards

Absolute Maximum Ratings

Stresses in excess of the absolute maximum ratings can cause permanent damage to the device. These are absolute stress ratings only, functional operation of the device is not implied at these or any other conditions in excess of those given in the operations sections of the data sheet. Exposure to absolute maximum ratings for extended periods can adversely affect the device reliability.

Parameter	Device	Symbol	Min	Max	Unit
Input Voltage Continuous	All	V_{IN}	-0.3	15	Vdc
Operating Ambient Temperature (see Thermal Considerations section)	All	T_A	-40	85	°C
Storage Temperature	All	T_{stg}	-55	125	°C

Electrical Specifications

Unless otherwise indicated, specifications apply over all operating input voltage, resistive load, and temperature conditions.

Parameter	Device	Symbol	Min	Typ	Max	Unit
Operating Input Voltage	All	V_{IN}	10	12.0	14.0	Vdc
Maximum Input Current ($V_{IN} = V_{IN, min}$ to $V_{IN, max}$; $I_O = I_{O, max}$; $V_{O, set} = 3.3Vdc$)	All	$I_{IN, max}$			6.5	Adc
Input No Load Current ($V_{IN} = 12.0Vdc$, $I_O = 0$, module enabled)	$V_{O, set} = 0.75 Vdc$	$I_{IN, No load}$		40		mA
	$V_{O, set} = 5.0Vdc$	$I_{IN, No load}$		100		mA
Input Stand-by Current ($V_{IN} = 12.0Vdc$, module disabled)	All	$I_{IN, stand-by}$		2.0		mA
Inrush Transient	All	I^2t			0.4	A ² s
Input Reflected Ripple Current, peak-to-peak (5Hz to 20MHz, 1μH source impedance; $V_{IN, min}$ to $V_{IN, max}$, $I_O = I_{O, max}$; See Test configuration section)	All			20		mAp-p
Input Ripple Rejection (120Hz)	All			30		dB

CAUTION: This power module is not internally fused. An input line fuse must always be used.

This power module can be used in a wide variety of applications, ranging from simple standalone operation to being part of a complex power architecture. To preserve maximum flexibility, internal fusing is not included, however, to achieve maximum safety and system protection, always use an input line fuse. The safety agencies require a fast-acting fuse with a maximum rating of 15 A (see Safety Considerations section). Based on the information provided in this data sheet on inrush energy and maximum dc input current, the same type of fuse with a lower rating can be used. Refer to the fuse manufacturer's data sheet for further information.

Electrical Specifications (continued)

Parameter	Device	Symbol	Min	Typ	Max	Unit
Output Voltage Set-point ($V_{IN}=V_{IN, min}$, $I_O=I_{O, max}$, $T_A=25^\circ\text{C}$)	All	$V_{O, set}$	-2.0	—	+2.0	% $V_{O, set}$
Output Voltage (Over all operating input voltage, resistive load, and temperature conditions until end of life)	All	$V_{O, set}$	-2.5%	—	+3.5%	% $V_{O, set}$
Adjustment Range Selected by an external resistor	All	V_O	-10		10	% $V_{O, set}$
Output Regulation Line ($V_{IN}=V_{IN, min}$ to $V_{IN, max}$)	All		—	0.3		% $V_{O, set}$
Load ($I_O=I_{O, min}$ to $I_{O, max}$)	All		—	0.4		% $V_{O, set}$
Temperature ($T_{ref}=T_{A, min}$ to $T_{A, max}$)	All		—	0.4		% $V_{O, set}$
Output Ripple and Noise on nominal output ($V_{IN}=V_{IN, nom}$ and $I_O=I_{O, min}$ to $I_{O, max}$ $C_{out} = 1\mu\text{F}$ ceramic//10 μF tantalum capacitors)						
RMS (5Hz to 20MHz bandwidth)	All		—	12	15	mV _{rms}
Peak-to-Peak (5Hz to 20MHz bandwidth)	All		—	30	50	mV _{pk-pk}
External Capacitance ESR ≥ 1 m Ω	All	$C_{O, max}$	—	—	1000	μF
ESR ≥ 10 m Ω	All	$C_{O, max}$	—	—	5000	μF
Output Current	All	I_o	0	—	10	Adc
Output Current Limit Inception (Hiccup Mode)	All	$I_{o, lim}$	—	200	—	% I_o
Output Short-Circuit Current ($V_O \leq 250\text{mV}$) (Hiccup Mode)	All	$I_{o, s/c}$	—	3	—	Adc
Efficiency $V_{IN} = V_{IN, nom}$, $T_A=25^\circ\text{C}$ $I_O=I_{O, max}$, $V_O = V_{O, set}$	$V_{O, set} = 1.2\text{Vdc}$	η		87.5		%
	$V_{O, set} = 1.5\text{Vdc}$	η		89.0		%
	$V_{O, set} = 1.8\text{Vdc}$	η		90.0		%
	$V_{O, set} = 2.5\text{Vdc}$	η		92.0		%
	$V_{O, set} = 3.3\text{Vdc}$	η		93.0		%
	$V_{O, set} = 5.0\text{Vdc}$	η		95.0		%
Switching Frequency	All	f_{sw}	—	300	—	kHz
Dynamic Load Response ($dI/dt=2.5\text{A}/\mu\text{s}$; $V_{IN} = V_{IN, nom}$; $T_A=25^\circ\text{C}$) Load Change from $I_o = 50\%$ to 100% of $I_{o, max}$; $1\mu\text{F}$ ceramic// $10\mu\text{F}$ tantalum Peak Deviation	All	V_{pk}	—	200	—	mV
Settling Time ($V_O < 10\%$ peak deviation)	All	t_s	—	25	—	μs
($dI/dt=2.5\text{A}/\mu\text{s}$; $V_{IN} = V_{IN, nom}$; $T_A=25^\circ\text{C}$) Load Change from $I_o = 100\%$ to 50% of $I_{o, max}$: $1\mu\text{F}$ ceramic// $10\mu\text{F}$ tantalum Peak Deviation	All	V_{pk}	—	200	—	mV
Settling Time ($V_O < 10\%$ peak deviation)	All	t_s	—	25	—	μs

Electrical Specifications (continued)

Parameter	Device	Symbol	Min	Typ	Max	Unit
Dynamic Load Response (dI _O /dt=2.5A/μs; V _{IN} = V _{IN, nom} ; T _A =25°C) Load Change from I _O = 50% to 100% of I _{O,max} ; C _O = 2x150 μF polymer capacitors Peak Deviation	All	V _{pk}	—	100	—	mV
Settling Time (V _O <10% peak deviation)	All	t _s	—	25	—	μs
(dI _O /dt=2.5A/μs; V _{IN} = V _{IN, nom} ; T _A =25°C) Load Change from I _O = 100% to 50% of I _{O,max} ; C _O = 2x150 μF polymer capacitors Peak Deviation	All	V _{pk}	—	100	—	mV
Settling Time (V _O <10% peak deviation)	All	t _s	—	25	—	μs

General Specifications

Parameter	Min	Typ	Max	Unit
Calculated MTBF (I _O =I _{O, max} , T _A =25°C)		4,400,000		Hours
Weight	—	5.6 (0.2)	—	g (oz.)

Feature Specifications

Unless otherwise indicated, specifications apply over all operating input voltage, resistive load, and temperature conditions. See Feature Descriptions for additional information.

Parameter	Device	Symbol	Min	Typ	Max	Unit
Remote On/Off Signal interface ($V_{IN}=V_{IN, min}$ to $V_{IN, max}$; Open collector npn or equivalent Compatible, Von/off signal referenced to GND See feature description section) Logic High (On/Off Voltage pin open - Module ON)						
Von/Off	All	V_{IH}	—	—	14	V
Ion/Off	All	I_{IH}	—	—	10	μ A
Logic Low (Von/Off \leq 0.3V – Module Off)						
Von/Off	All	V_{IL}	—	—	0.3	V
Ion/off	All	I_{IL}	—	—	1	mA
Turn-On Delay and Rise Times ($I_O=I_{O, max}$, $V_{IN} = V_{IN, nom}$, $T_A = 25^\circ\text{C}$,) Case 1: On/Off input is set to Logic Low (Module ON) and then input power is applied (delay from instant at which $V_{IN} = V_{IN, min}$ until $V_o=10\%$ of $V_{o, set}$) Case 2: Input power is applied for at least one second and then the On/Off input is set to logic Low (delay from instant at which Von/Off=0.3V until $V_o=10\%$ of $V_{o, set}$) Output voltage Rise time (time for V_o to rise from 10% of $V_{o, set}$ to 90% of $V_{o, set}$)						
	All	Tdelay		3		msec
	All	Tdelay		3		msec
	All	Trise	—	4	6	msec
Output voltage overshoot – Startup $I_O= I_{O, max}$; $V_{IN} = 3.0$ to 5.5Vdc, $T_A = 25^\circ\text{C}$				—	1	% $V_{O, set}$
Remote Sense Range	All		—	—	0.5	V
Overtemperature Protection (See Thermal Consideration section)	All	T_{ref}	—	125	—	$^\circ\text{C}$
Input Undervoltage Lockout						
Turn-on Threshold	All		—	8.2	—	V
Turn-off Threshold	All		—	8.0	—	V

Characteristic Curves

The following figures provide typical characteristics for the Austin Lynx™ 12 V SMT modules at 25°C.

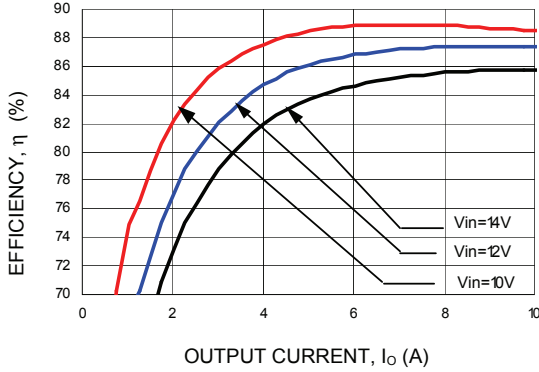

Figure 1. Converter Efficiency versus Output Current ($V_{out} = 1.2Vdc$).

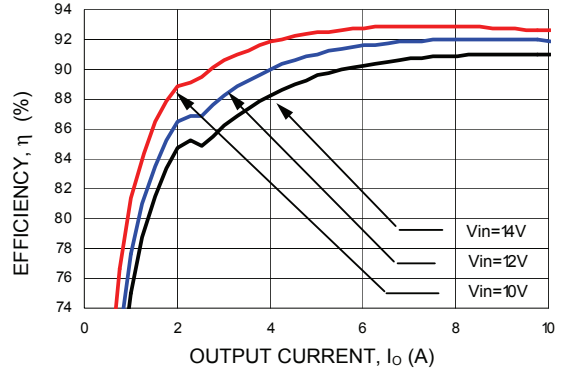

Figure 4. Converter Efficiency versus Output Current ($V_{out} = 2.5Vdc$).

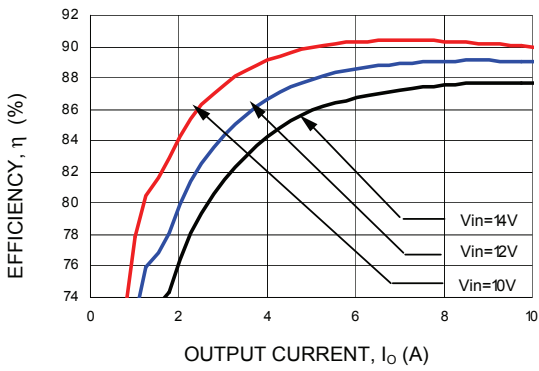

Figure 2. Converter Efficiency versus Output Current ($V_{out} = 1.5Vdc$).

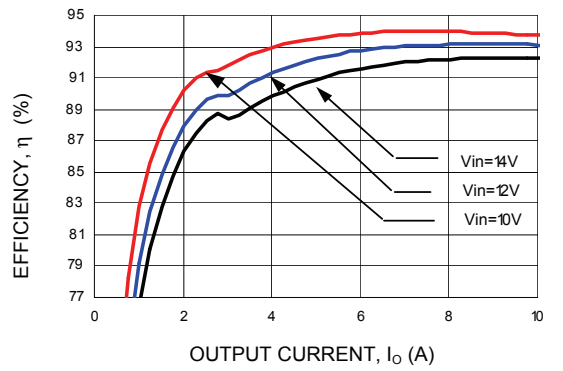

Figure 5. Converter Efficiency versus Output Current ($V_{out} = 3.3Vdc$).

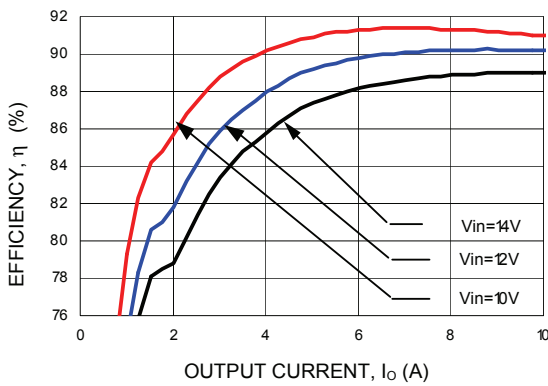

Figure 3. Converter Efficiency versus Output Current ($V_{out} = 1.8Vdc$).

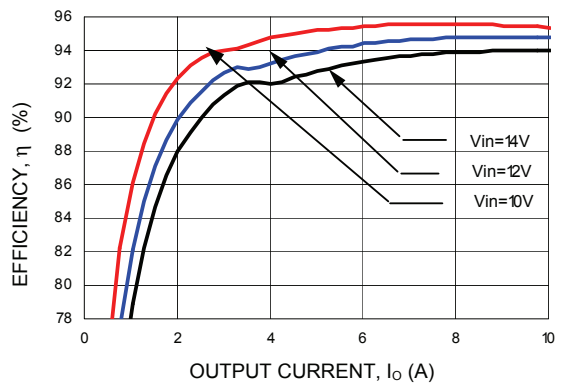

Figure 6. Converter Efficiency versus Output Current ($V_{out} = 5.0Vdc$).

Characteristic Curves (continued)

The following figures provide typical characteristics for the Austin Lynx™ 12 V SMT modules at 25°C.

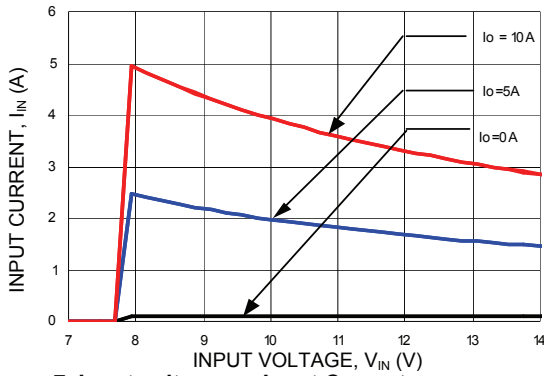

Figure 7. Input voltage vs. Input Current
 (V_{out} = 3.3Vdc).

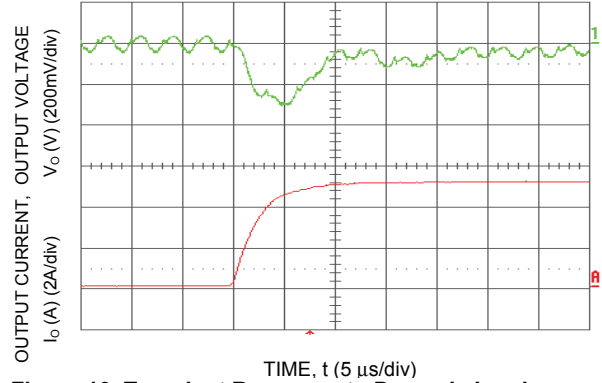

Figure 10. Transient Response to Dynamic Load Change from 50% to 100% of full load (V_o = 3.3Vdc).

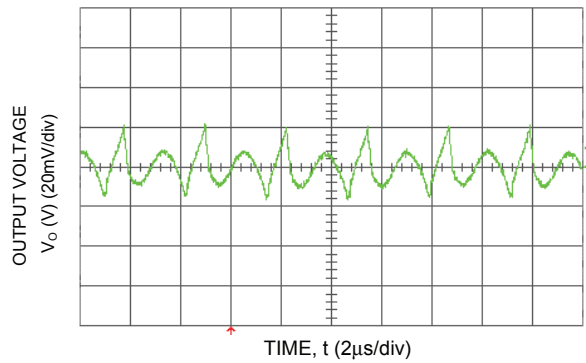

Figure 8. Typical Output Ripple and Noise
 (V_{in} = 12.0V dc, V_o = 2.5 Vdc, I_o=10A).

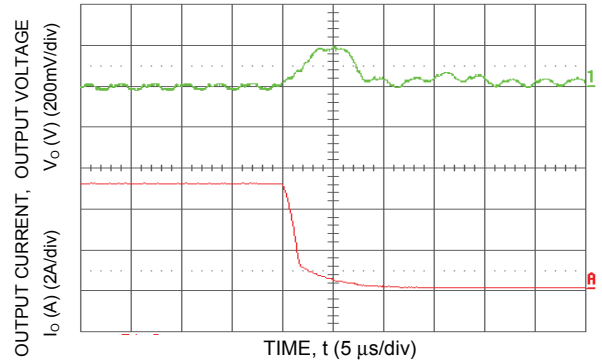

Figure 11. Transient Response to Dynamic Load Change from 100% to 50% of full load (V_o = 3.3 Vdc).

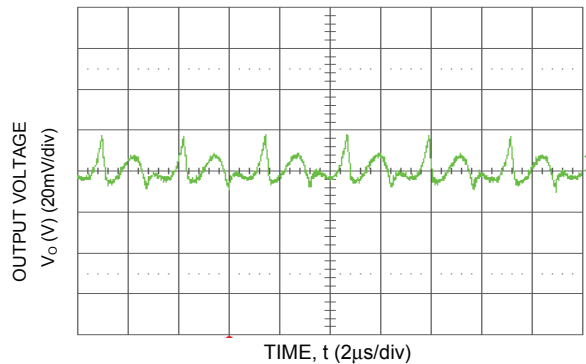

Figure 9. Typical Output Ripple and Noise
 (V_{in} = 12.0V dc, V_o = 5.0 Vdc, I_o=10A).

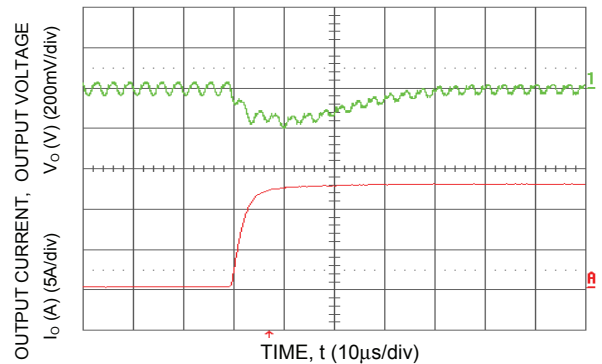

Figure 12. Transient Response to Dynamic Load Change from 50% to 100% of full load (V_o = 3.3 Vdc, C_{ext} = 2x150 µF Polymer Capacitors).

Characteristic Curves (continued)

The following figures provide typical characteristics for the Austin Lynx™ 12 V SMT modules at 25°C.

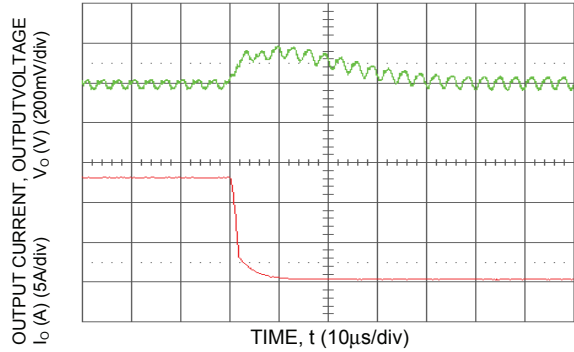

Figure 13. Transient Response to Dynamic Load Change from 100% of 50% full load ($V_o = 3.3\text{ Vdc}$, $C_{ext} = 2 \times 150\ \mu\text{F}$ Polymer Capacitors).

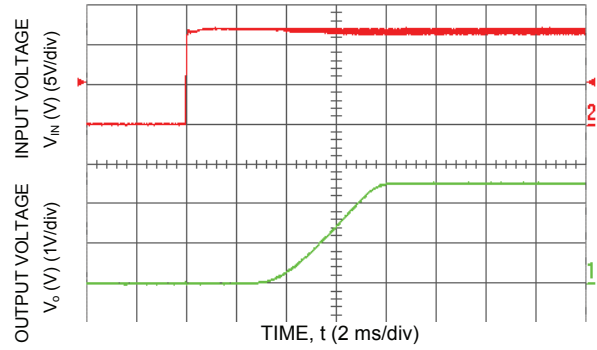

Figure 16. Typical Start-Up with application of V_{in} with low-ESR polymer capacitors at the output ($7 \times 150\ \mu\text{F}$) ($V_{in} = 12\text{ Vdc}$, $V_o = 5.0\text{ Vdc}$, $I_o = 10\text{ A}$, $C_o = 1050\ \mu\text{F}$).

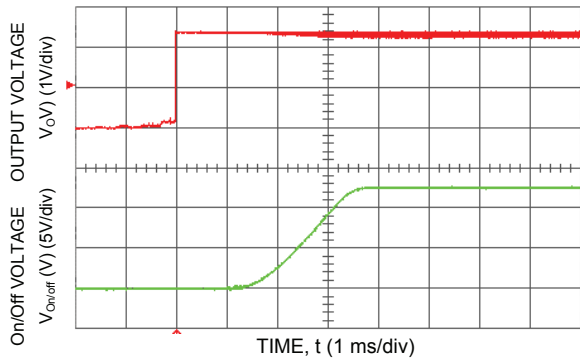

Figure 14. Typical Start-Up Using Remote On/Off ($V_{in} = 12.0\text{ Vdc}$, $V_o = 5.0\text{ Vdc}$, $I_o = 10.0\text{ A}$).

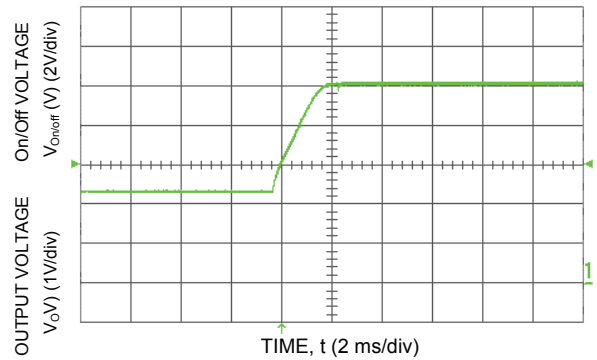

Figure 17 Typical Start-Up Using Remote On/Off with Prebias ($V_{in} = 12.0\text{ Vdc}$, $V_o = 2.5\text{ Vdc}$, $I_o = 1.0\text{ A}$, $V_{bias} = 1.2\text{ Vdc}$).

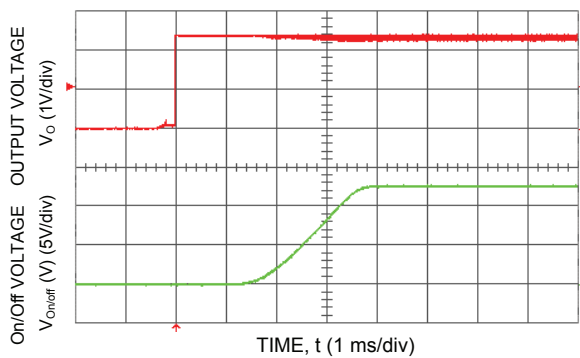

Figure 15. Typical Start-Up Using Remote On/Off with Low-ESR external capacitors ($C_o = 5000\ \mu\text{F}$) ($V_{in} = 12.0\text{ Vdc}$, $V_o = 5.0\text{ Vdc}$, $I_o = 10.0\text{ A}$, $C_o = 1050\ \mu\text{F}$).

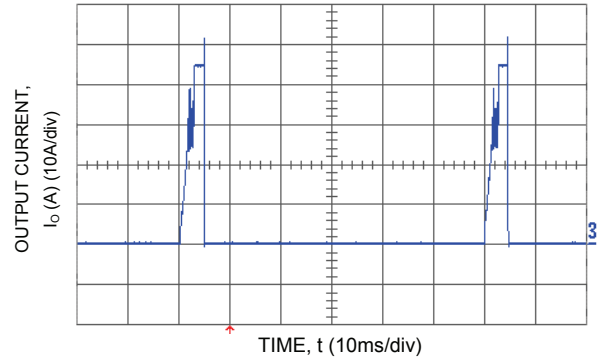

Figure 18. Output short circuit Current ($V_{in} = 12.0\text{ Vdc}$, $V_o = 0.75\text{ Vdc}$).

Characteristic Curves (continued)

The following figures provide thermal derating curves for the Austin Lynx™ 12 V SMT modules.

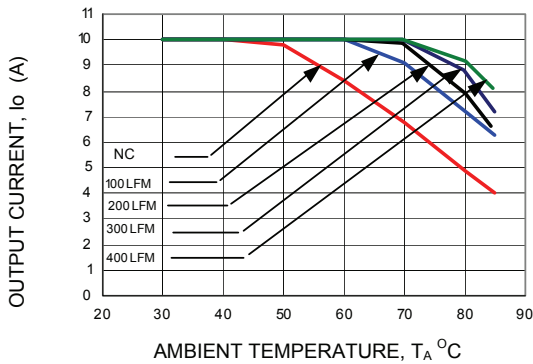

Figure 19. Derating Output Current versus Local Ambient Temperature and Airflow ($V_{in} = 12.0$ Vdc, $V_o=0.75$ Vdc).

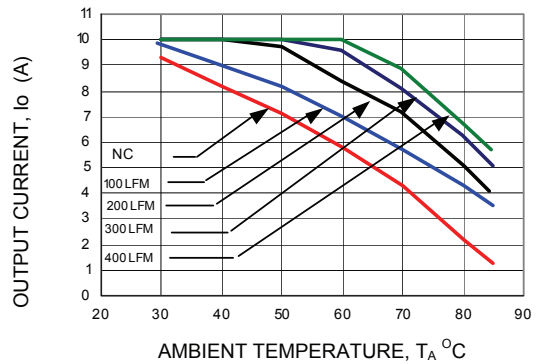

Figure 22. Derating Output Current versus Local Ambient Temperature and Airflow ($V_{in} = 12.0$ Vdc, $V_o=5.0$ Vdc).

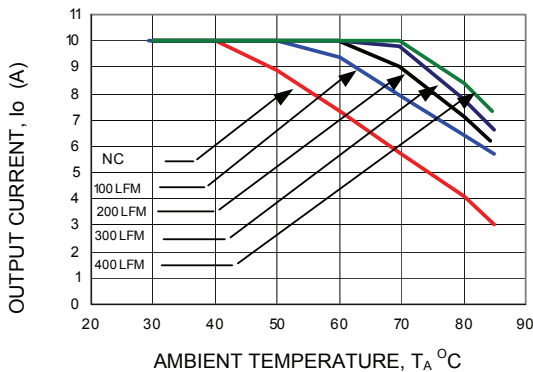

Figure 20. Derating Output Current versus Local Ambient Temperature and Airflow ($V_{in} = 12.0$ Vdc, $V_o=1.8$ Vdc).

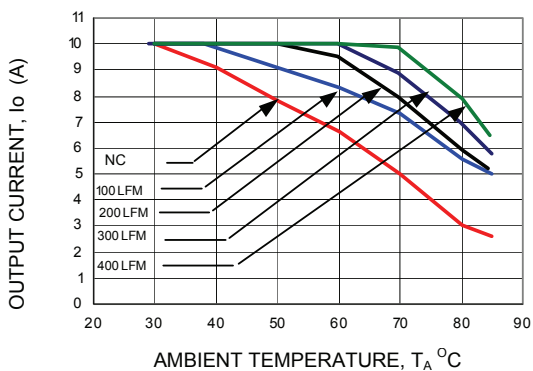
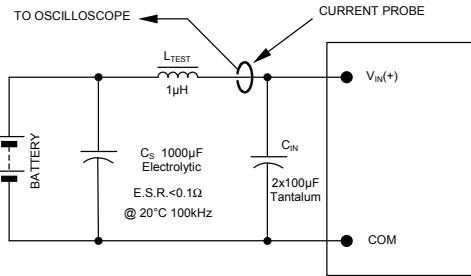

Figure 21. Derating Output Current versus Local Ambient Temperature and Airflow ($V_{in} = 12.0$ Vdc, $V_o=3.3$ Vdc).

Test Configurations



NOTE: Measure input reflected ripple current with a simulated source inductance (L_{TEST}) of 1µH. Capacitor C_S offsets possible battery impedance. Measure current as shown above.

Figure 23. Input Reflected Ripple Current Test Setup.

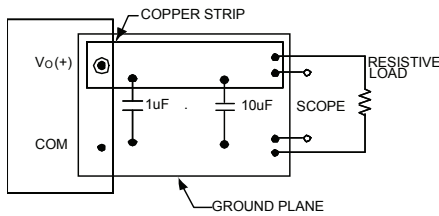

NOTE: All voltage measurements to be taken at the module terminals, as shown above. If sockets are used then Kelvin connections are required at the module terminals to avoid measurement errors due to socket contact resistance.

Figure 24. Output Ripple and Noise Test Setup.

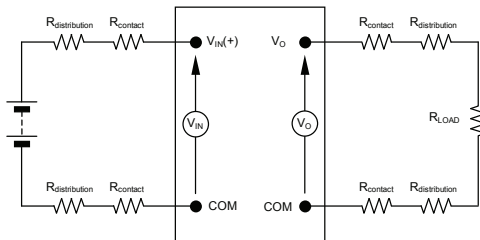

NOTE: All voltage measurements to be taken at the module terminals, as shown above. If sockets are used then Kelvin connections are required at the module terminals to avoid measurement errors due to socket contact resistance.

Figure 25. Output Voltage and Efficiency Test Setup.

$$\text{Efficiency } \eta = \frac{V_O \cdot I_O}{V_{IN} \cdot I_{IN}} \times 100 \%$$

Design Considerations

Input Filtering

Austin Lynx™ 12V SMT module should be connected to a low-impedance source. A highly inductive source can affect the stability of the module. An input capacitance must be placed directly adjacent to the input pin of the module, to minimize input ripple voltage and ensure module stability.

In a typical application, 4x47 µF low-ESR tantalum capacitors (AVX part #: TPSE476M025R0100, 47µF 25V 100 mΩ ESR tantalum capacitor) will be sufficient to provide adequate ripple voltage at the input of the module. To minimize ripple voltage at the input, low ESR ceramic capacitors are recommended at the input of the module. Figure 26 shows input ripple voltage (mVp-p) for various outputs with 4x47 µF tantalum capacitors and with 4x22 µF ceramic capacitor (TDK part #: C4532X5R1C226M) at full load.

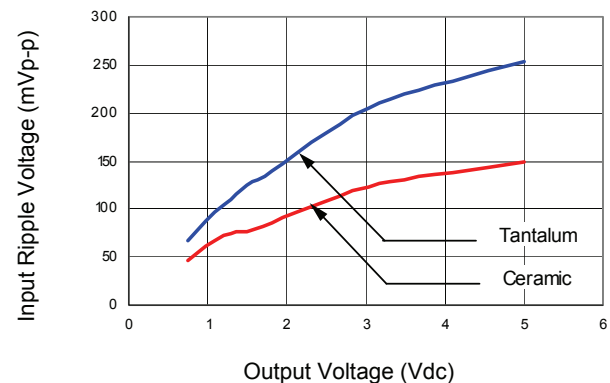

Figure 26. Input ripple voltage for various output with 4x22 µF polymer and 4x47 µF ceramic capacitors at the input (full load).

Design Considerations (continued)

Output Filtering

The Austin Lynx™ 12 V SMT module is designed for low output ripple voltage and will meet the maximum output ripple specification with 1 μ F ceramic and 10 μ F tantalum capacitors at the output of the module. However, additional output filtering may be required by the system designer for a number of reasons. First, there may be a need to further reduce the output ripple and noise of the module. Second, the dynamic response characteristics may need to be customized to a particular load step change.

To reduce the output ripple and improve the dynamic response to a step load change, additional capacitance at the output can be used. Low ESR polymer and ceramic capacitors are recommended to improve the dynamic response of the module. For stable operation of the module, limit the capacitance to less than the maximum output capacitance as specified in the electrical specification table.

Safety Considerations

For safety agency approval the power module must be installed in compliance with the spacing and separation requirements of the end-use safety agency standards, i.e., UL 60950-1, CSA C22.2 No. 60950-1-03, and VDE 0850:2001-12 (EN60950-1) Licensed.

For the converter output to be considered meeting the requirements of safety extra-low voltage (SELV), the input must meet SELV requirements. The power module has extra-low voltage (ELV) outputs when all inputs are ELV.

The input to these units is to be provided with a fast-acting fuse with a maximum rating of 20A in the positive input lead.

Feature Description

Remote On/Off

The Austin Lynx™ 12V SMT power modules feature an On/Off pin for remote On/Off operation. If not using the remote On/Off pin, leave the pin open (module will be On). The On/Off pin signal (V_{ON/Off}) is referenced to ground. To switch the module on and off using remote On/Off, connect an open collector npn transistor between the On/Off pin and the ground pin (See Figure 27).

During a logic-high (On/Off pin is pulled high internal to the module) when the transistor is in the Off state, the power module is ON. The maximum allowable leakage current of the transistor when V_{on/off} = V_{IN,max} is 10µA. During a logic-low when the transistor is turned-on, the power module is OFF. During this state V_{ON/Off} is less than 0.3V and the maximum I_{ON/Off} = 1mA.

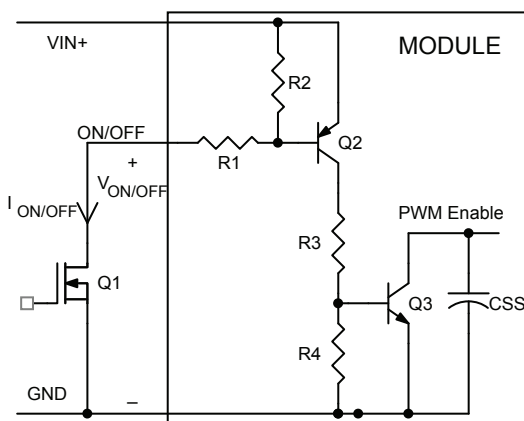

Figure 27. Remote On/Off Implementation.

Overcurrent Protection

To provide protection in a fault (output overload) condition, the unit is equipped with internal current-limiting circuitry and can endure current limiting continuously. At the point of current-limit inception, the unit enters hiccup mode. The unit operates normally once the output current is brought back into its specified range. The typical average output current during hiccup is 3 A.

Input Undervoltage Lockout

At input voltages below the input undervoltage lockout limit, module operation is disabled. The module will begin to operate at an input voltage above the undervoltage lockout turn-on threshold.

Overtemperature Protection

To provide over temperature protection in a fault condition, the unit relies upon the thermal protection feature of the controller IC. The unit will shutdown if the thermal reference point T_{ref}, exceeds 125°C (typical), but

the thermal shutdown is not intended as a guarantee that the unit will survive temperatures beyond its rating. The module will automatically restart after it cools down.

Output Voltage Programming

The output voltage adjustment feature allows the output voltage set point to be increased or decreased by connecting an external resistor between the TRIM pin and V_o pin (decrease output voltage) or GND pin (increase output voltage).

To trim up output voltage set point using an external resistor, connect *R_{trim-up}* between the TRIM and GND pins (Figure 28). The value of *R_{trim-up}* resistor is defined as:

$$R_{trim-up} = \left[\frac{10500}{V_o - V_{o,set}} - 1000 \right] \Omega$$

R_{trim-up} is the external resistor in Ω

V_{o,set} is the nominal output voltage

V_o is the desired trim-up voltage

For example, to trim up the output voltage of the 1.5V module (AXA010A0M93-SR) by 8% to 1.62V, *R_{trim-up}* is calculated as follows:

V_{o,set} = 1.5V

V_o = 1.62V:

$$R_{trim-up} = \left[\frac{10500}{1.62 - 1.5} - 1000 \right]$$

$$R_{trim-up} = 86.5k\Omega$$

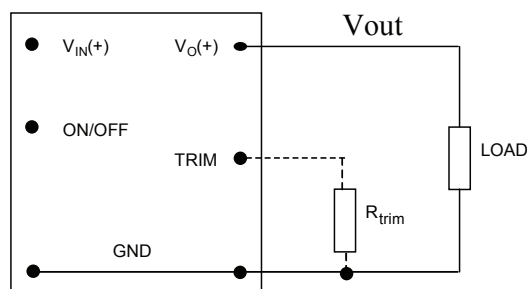

Figure 28. Circuit configuration for programming output voltage using an external resistor.

To trim down output voltage set point using an external resistor, connect *R_{trim-down}* between TRIM and V_o pins (Figure 29). The value of *R_{trim-down}* resistor is defined as:

$$R_{trim-down} = \left[\frac{(V_o - 0.7)15000}{V_{o,set} - V_o} - 1000 \right] \Omega$$

Feature Descriptions (continued)

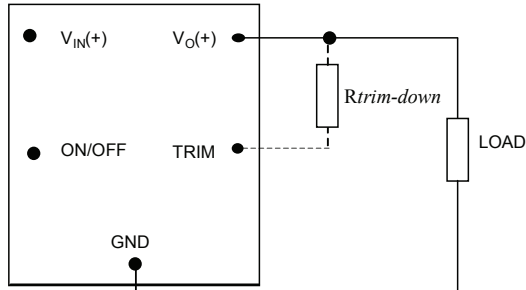

Figure 29. Circuit configuration to trim-down output voltage using an external resistor

$R_{trim-down}$ is the external resistor in Ω
 $V_{o,set}$ is the nominal output voltage
 V_o is the desired trim-down voltage

For example, to trim down the output voltage of the 2.5V module (AXA010A0G93-SR) by 8% to 2.3V, $R_{trim-down}$ is calculated as follows:

$V_{o,set} = 2.5V$
 $V_o = 2.3V$

$$R_{trim-down} = \left[\frac{(2.3 - 0.7)15000}{2.5 - 2.3} - 1000 \right] \Omega$$

$$R_{trim-down} = 119k\Omega$$

The amount of power delivered by the module is defined as the voltage at the output terminals multiplied by the output current. When using the trim feature, the output voltage of the module can be increased, which at the same output current would increase the power output of the module. Care should be taken to ensure that the maximum output power of the module remains at or below the maximum rated power ($P_{max} = V_{o,set} \times I_{o,max}$).

Remote Sense

The Austin Lynx™ 12V SMT power modules have a Remote Sense feature to minimize the effects of distribution losses by regulating the voltage at the Remote Sense and GND pins (See Figure 30). The voltage between the Sense pin and V_o pin must not exceed 0.5V. Although both the Remote Sense and the TRIM features can increase the output voltage V_o , the maximum increase is not the sum of both. The maximum V_o increase is the larger of either the Remote Sense or TRIM.

The amount of power delivered by the module is defined as the output voltage multiplied by the output current ($V_o \times I_o$). When using Remote Sense and/or TRIM, the output voltage of the module can increase, which if the same output is maintained, increases the power output by the module. Make sure that the maximum output power of the module remains at or below the maximum rated power. When the Remote Sense feature is not being used, leave the Remote Sense pin unconnected.

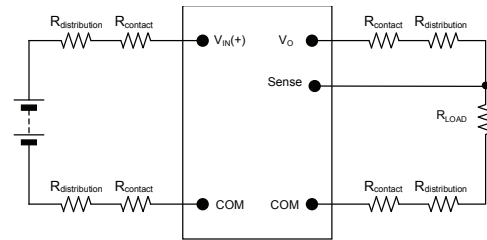

Figure 30. Remote sense circuit configuration

Thermal Considerations

Power modules operate in a variety of thermal environments; however, sufficient cooling should always be provided to help ensure reliable operation.

Considerations include ambient temperature, airflow, module power dissipation, and the need for increased reliability. A reduction in the operating temperature of the module will result in an increase in reliability. The thermal data presented here is based on physical measurements taken in a wind tunnel. The test set-up is shown in Figure 32. Note that the airflow is parallel to the short axis of the module as shown in figure 31. The derating data applies to airflow in either direction of the module's short axis.

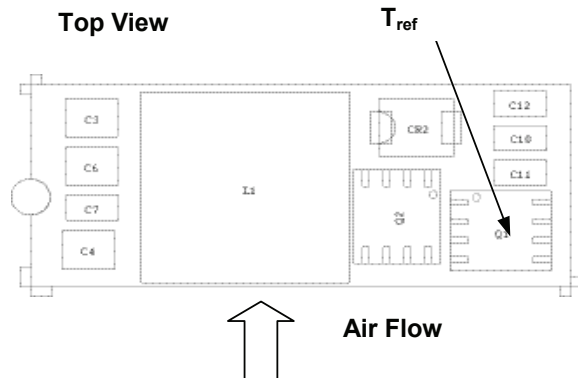

Figure 31. T_{ref} Temperature measurement location.

The thermal reference point, T_{ref} used in the specifications is shown in Figure 31. For reliable operation this temperature should not exceed 115°C.

The output power of the module should not exceed the rated power of the module ($V_{o,set} \times I_{o,max}$).

Please refer to the Application Note “Thermal Characterization Process For Open-Frame Board-Mounted Power Modules” for a detailed discussion of thermal aspects including maximum device temperatures.

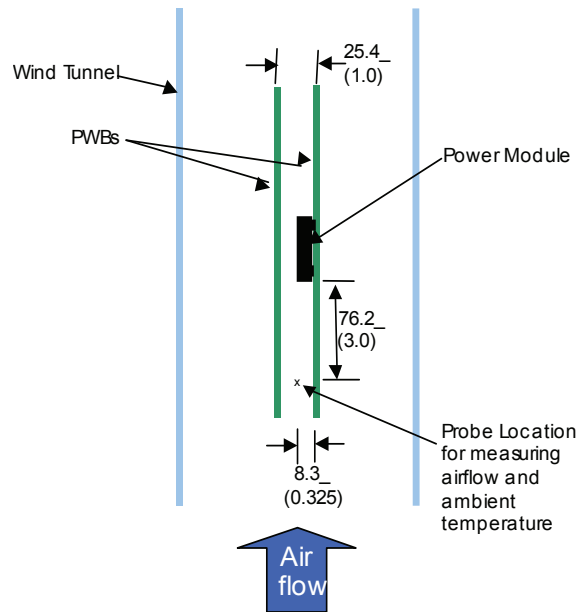

Figure 32. Thermal Test Set-up.

Heat Transfer via Convection

Increased airflow over the module enhances the heat transfer via convection. Thermal derating curves showing the maximum output current that can be delivered at different local ambient temperatures (T_A) for airflow conditions ranging from natural convection and up to 2m/s (400 ft./min) are shown in the Characteristics Curves section.

Layout Considerations

Copper paths must not be routed beneath the power module. For additional layout guide-lines, refer to the FLTR100V10 application note.

Mechanical Outline

Dimensions are in inches and (millimeters).

Tolerances: x.xx in. \pm 0.02 in. (x.x mm \pm 0.5 mm) [unless otherwise indicated]

x.xxx in \pm 0.010 in. (x.xx mm \pm 0.25 mm)

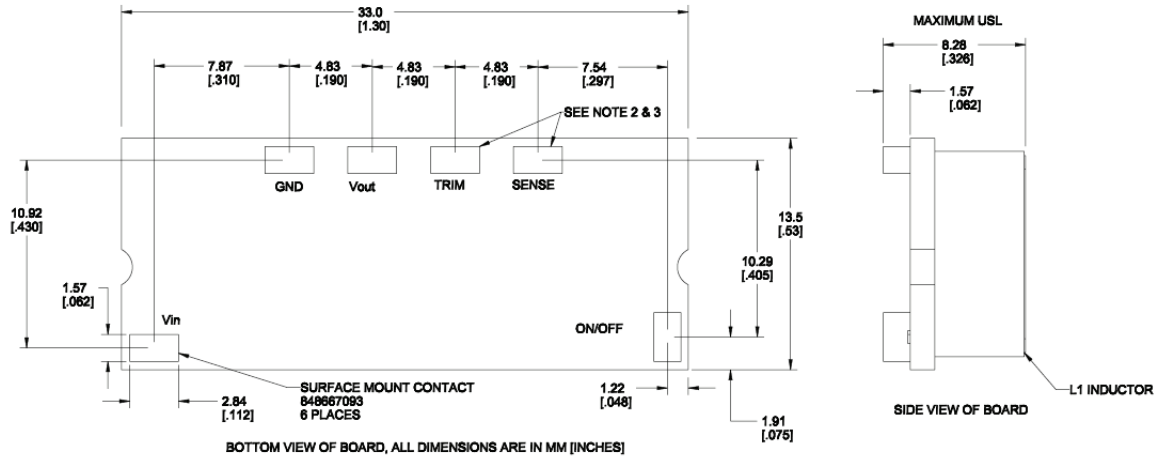

Recommended Pad Layout

Dimensions are in inches and (millimeters).

Tolerances: x.xx in. \pm 0.02 in. (x.x mm \pm 0.5 mm) [unless otherwise indicated]

x.xxx in \pm 0.010 in. (x.xx mm \pm 0.25 mm)

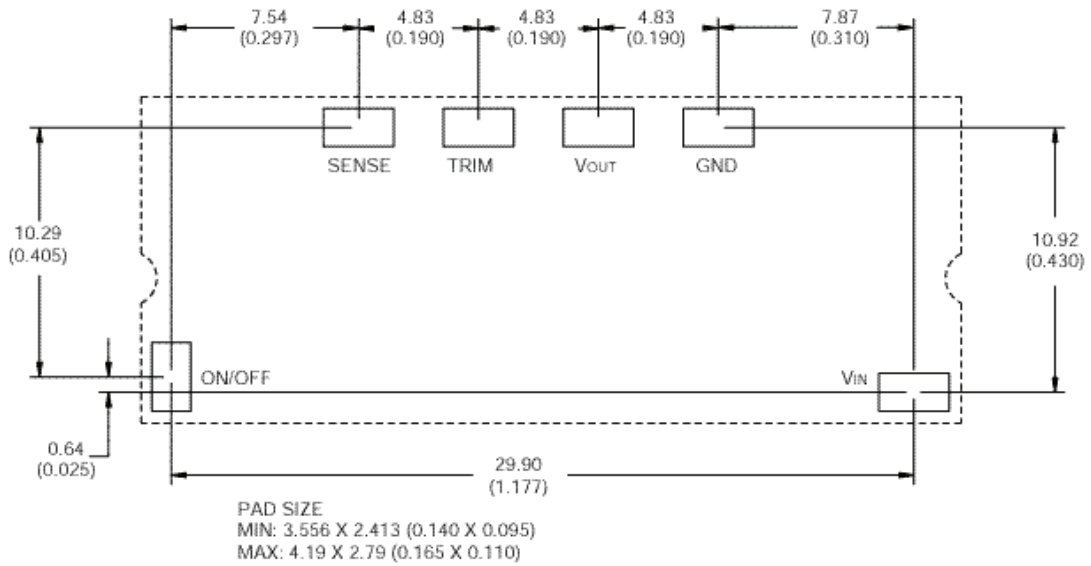

Packaging Details

The Austin Lynx™ 12 V SMT version is supplied in tape & reel as standard. Modules are shipped in quantities of 250 modules per reel.

All Dimensions are in millimeters and (in inches).

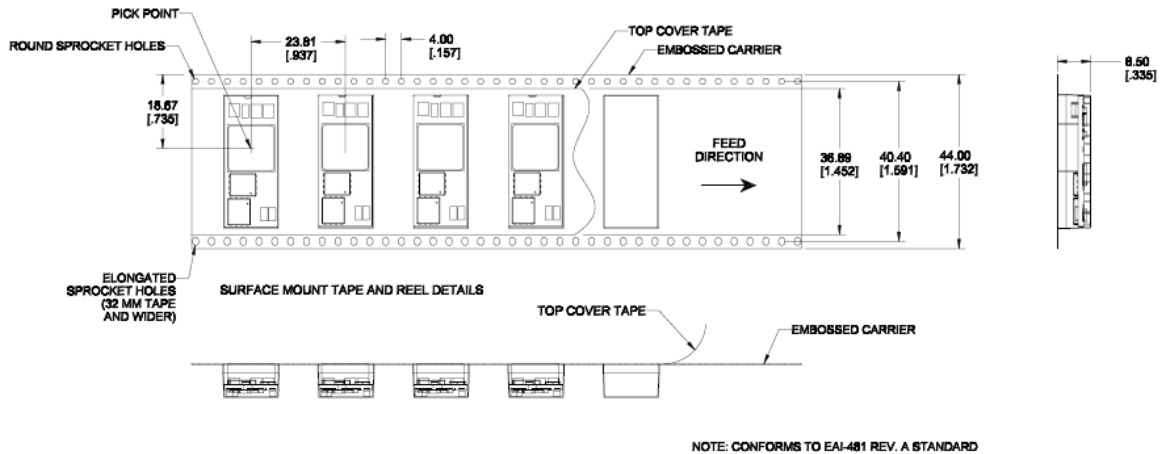

Reel Dimensions:
Outside Dimensions: 330.2 mm (13.00)
Inside Dimensions: 177.8 mm (7.00")
Tape Width: 44.00 mm (1.732")

Surface Mount Information

Pick and Place

The Austin Lynx™ 12 V SMT modules use an open frame construction and are designed for a fully automated assembly process. The modules are fitted with a label designed to provide a large surface area for pick and place operations. The label meets all the requirements for surface mount processing, as well as safety standards, and is able to withstand reflow temperatures of up to 300°C. The label also carries product information such as product code, serial number and the location of manufacture.

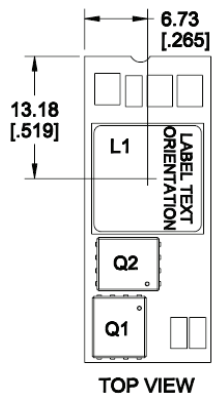

Figure 33. Pick and Place Location.

Nozzle Recommendations

The module weight has been kept to a minimum by using open frame construction. Even so, these modules have a relatively large mass when compared to conventional SMT components. Variables such as nozzle size, tip style, vacuum pressure and placement speed should be considered to optimize this process. The minimum recommended nozzle diameter for reliable operation is 6mm. The maximum nozzle outer diameter, which will safely fit within the allowable component spacing, is 9 mm.

Oblong or oval nozzles up to 11 x 9 mm may also be used within the space available.

Tin Lead Soldering

The Austin Lynx™ 12 V SMT power modules are lead free modules and can be soldered either in a lead-free solder process or in a conventional Tin/Lead (Sn/Pb) process. It is recommended that the customer review data sheets in order to customize the solder reflow profile for each application board assembly. The following instructions must be observed when soldering these units. Failure to observe these

instructions may result in the failure of or cause damage to the modules, and can adversely affect long-term reliability.

In a conventional Tin/Lead (Sn/Pb) solder process peak reflow temperatures are limited to less than 235°C. Typically, the eutectic solder melts at 183°C, wets the land, and subsequently wicks the device connection. Sufficient time must be allowed to fuse the plating on the connection to ensure a reliable solder joint. There are several types of SMT reflow technologies currently used in the industry. These surface mount power modules can be reliably soldered using natural forced convection, IR (radiant infrared), or a combination of convection/IR. For reliable soldering the solder reflow profile should be established by accurately measuring the modules CP connector temperatures.

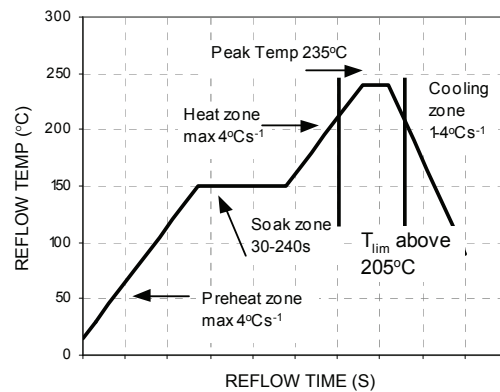

Figure 34. Reflow Profile for Tin/Lead (Sn/Pb) process.

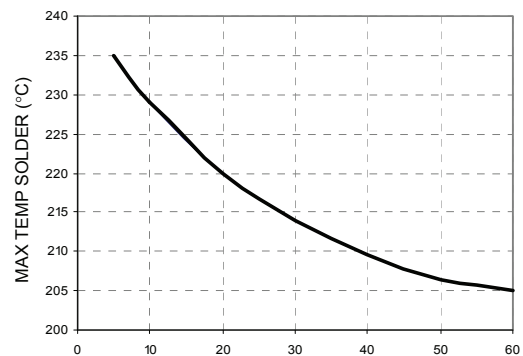

Figure 35. Time Limit Curve Above 205°C for Tin/Lead (Sn/Pb) process.

Surface Mount Information (continued)

Lead Free Soldering

The –Z version Austin Lynx 12V SMT modules are lead-free (Pb-free) and RoHS compliant and are both forward and backward compatible in a Pb-free and a SnPb soldering process. Failure to observe the instructions below may result in the failure of or cause damage to the modules and can adversely affect long-term reliability.

Pb-free Reflow Profile

Power Systems will comply with J-STD-020 Rev. C (Moisture/Reflow Sensitivity Classification for Nonhermetic Solid State Surface Mount Devices) for both Pb-free solder profiles and MSL classification procedures. This standard provides a recommended forced-air-convection reflow profile based on the volume and thickness of the package (table 4-2). The suggested Pb-free solder paste is Sn/Ag/Cu (SAC). The recommended linear reflow profile using Sn/Ag/Cu solder is shown in Fig. 36.

MSL Rating

The Austin Lynx 12V SMT modules have a MSL rating of 2.

Storage and Handling

The recommended storage environment and handling procedures for moisture-sensitive surface mount packages is detailed in J-STD-033 Rev. A (Handling, Packing, Shipping and Use of Moisture/Reflow Sensitive Surface Mount Devices). Moisture barrier bags (MBB) with desiccant are required for MSL ratings of 2 or greater. These sealed packages should not be broken until time of use. Once the original package is broken, the floor life of the product at conditions of $\leq 30^{\circ}\text{C}$ and 60% relative humidity varies according to the MSL rating (see J-STD-033A). The shelf life for dry packed SMT packages will be a minimum of 12 months from the bag seal date, when stored at the following conditions: $< 40^{\circ}\text{C}$, $< 90\%$ relative humidity.

Post Solder Cleaning and Drying Considerations

Post solder cleaning is usually the final circuit-board assembly process prior to electrical board testing. The result of inadequate cleaning and drying can affect both the reliability of a power module and the testability of the finished circuit-board assembly. For guidance on appropriate soldering, cleaning and drying procedures, refer to *Board Mounted Power*

Modules: Soldering and Cleaning Application Note (AN04-001).

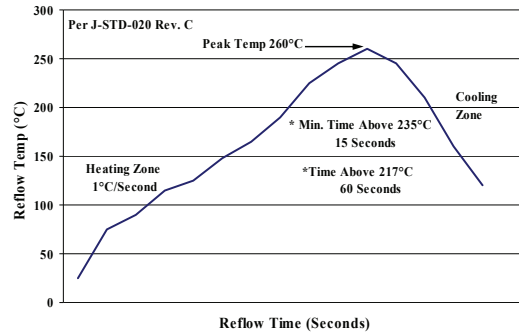

Figure 36. Recommended linear reflow profile using Sn/Ag/Cu solder.

Ordering Information

Please contact your Lineage Power Sales Representative for pricing, availability and optional features.

Table 3. Device Codes

Device Code	Input Voltage	Output Voltage	Output Current	Efficiency	Connector Type	Packaging	Comcodes
AXA010A0P93-SR	10 – 14Vdc	1.2 V	10 A	87.5%	SMT	Tape & Reel	108970112
AXA010A0M93-SR	10 – 14Vdc	1.5 V	10 A	89.0%	SMT	Tape & Reel	108970096
AXA010A0Y93-SR	10 – 14Vdc	1.8 V	10 A	90.0%	SMT	Tape & Reel	108969726
AXA010A0G93-SR	10 – 14Vdc	2.5 V	10 A	92.0%	SMT	Tape & Reel	108970070
AXA010A0F93-SR	10 – 14Vdc	3.3 V	10 A	93.0%	SMT	Tape & Reel	108970054
AXA010A0A93-SR	10 – 14Vdc	5.0 V	10 A	95.0%	SMT	Tape & Reel	108970013
AXA010A0P93-SRZ	10 – 14Vdc	1.2 V	10 A	87.5%	SMT	Tape & Reel	CC109102885
AXA010A0M93-SRZ	10 – 14Vdc	1.5 V	10 A	89.0%	SMT	Tape & Reel	CC109102877
AXA010A0Y93-SRZ	10 – 14Vdc	1.8 V	10 A	90.0%	SMT	Tape & Reel	CC109102902
AXA010A0G93-SRZ	10 – 14Vdc	2.5 V	10 A	92.0%	SMT	Tape & Reel	CC109102860
AXA010A0F93-SRZ	10 – 14Vdc	3.3 V	10 A	93.0%	SMT	Tape & Reel	CC109102852
AXA010A0A93-SRZ	10 – 14Vdc	5.0 V	10 A	95.0%	SMT	Tape & Reel	CC109106787

-Z refers to RoHS-compliant codes



World Wide Headquarters
Lineage Power Corporation
601 Shiloh Road, Plano, TX 75074, USA
+1-800-526-7819
(Outside U.S.A.: **+1-972-244-9428**)
www.lineagepower.com
e-mail: techsupport1@lineagepower.com

Asia-Pacific Headquarters
Tel: +65 6593 7211

Europe, Middle-East and Africa Headquarters
Tel: +49 898 780 672 80

India Headquarters
Tel: +91 80 28411633

Lineage Power reserves the right to make changes to the product(s) or information contained herein without notice. No liability is assumed as a result of their use or application. No rights under any patent accompany the sale of any such product(s) or information.

Lineage Power DC-DC products are protected under various patents. Information on these patents is available at www.lineagepower.com/patents.

© 2009 Lineage Power Corporation, (Plano, Texas) All International Rights Reserved.